

PRODUCT DESCRIPTION

- Designed to reach an IP67 waterproof rating
- Minimum dimensions for LED strips 10 mm wide
- Simple assembly
- Versatile application
- Low weight

FINISH :

Non anodized (raw) Silver anodized Black anodized RAL 

*Custom colors available upon request

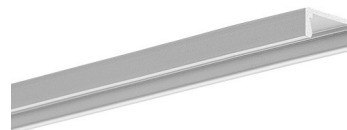

Fill empty fields

Product nr.

Fixture type

Company

Job name

Date

TECHNICAL SPECIFICATION

Application

- intended mainly for interiors, e.g. lighting of cabinets, stairs, display windows etc. With their small size, the lighting fixtures can be concealed in the walls of the furniture with small cross-sections
- in the sealed version, it can be used outdoors, for example on the facade of buildings, in the elements of garden architecture, in fencing elements, etc.

Assembly

- can be mounted with appropriately selected fixing glues, professional double-sided adhesive tapes, metal and plastic mounting brackets, as well as mounting brackets with angle adjustment, and by means of a mounting spring

Additional information

- possibility of making a linear fixture with IP67 protection, which means the fixture is dustproof and waterproof
- achieving IP67 is possible with the following covers: LIGER, KA, HS, KA-PRO and KA-COM
- can be equipped with transparent and frosted covers (diffusers), aluminum-colored plastic end caps, metalized and conductive end caps
- must not be used for diodes emitting high temperatures
- space for LED strip: 11.2 mm

Profile bending Suitable for bending in the plane adjacent to the LED strip.

Minimum internal radius	Minimum external radius
150 mm	150 mm

- minimum radius - bending radius which when exceeded causes destruction (deformation, bending or lack of compatibility with other accessories, e.g. covers, end caps, etc.) of the profile
- internal radius - refers to the profile bent so that the cover is facing the inside of the arch
- external radius - refers to the profile bent so that the cover is facing the outside of the arch
- irregular curves are possible after consultation and individual quotation
- when bending anodized profiles, one should be aware of cracking of the anode coating (which may be more or less visible depending on the radius)

Line of light

- ✓ = Line of Light
- X = Visible dotting

Profile:	LED Model:	HS/HS-12/HS-22 frosted	Liger/Liger-22 frosted	Liger/Liger-22 black	KA frosted	KA-PRO frosted	M-K frosted
MICRO-ALU							
	1210	X	X	X	X	X	X
	1220	X	X	X	X	X	X
	1275	X	X	X	X	X	✓
	0530	X	X	X	X	X	✓
	1910	X	X	X	X	X	✓
	1820	X	✓ (Hot line)	X	X	X	✓

AVAILABLE LENGTHS

Ref. nr.	surface finish	available lengths
B1888NA_1	Non anodized (raw)	1000 mm
B1888NA_2	Non anodized (raw)	2000 mm
B1888NA_3	Non anodized (raw)	3000 mm
B1888ANODA_1	Silver anodized	1000 mm
B1888ANODA_2	Silver anodized	2000 mm
B1888ANODA_3	Silver anodized	3000 mm
B1888K7_1	Black anodized	1000 mm
B1888K7_2	Black anodized	2000 mm
B1888L9010NS_1	White RAL	1000 mm
B1888L9010NS_2	White RAL	2000 mm
B1888L9005NS_1	Black RAL	1000 mm
B1888L9005NS_2	Black RAL	2000 mm

TECHNICAL DRAWING

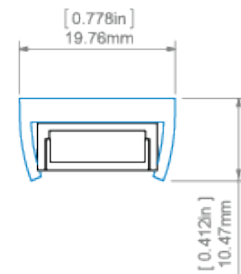
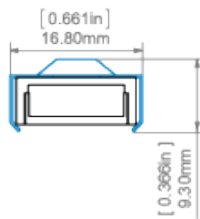
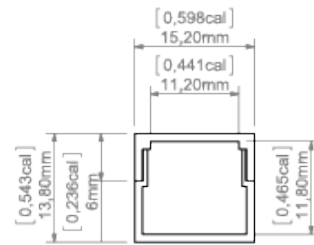
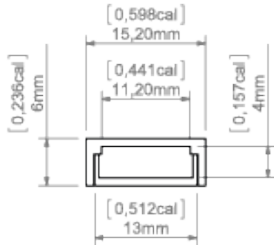

MICRO-ALU profile and PDS-STN mounting bracket
profil MICRO-ALU z mocownikiem PDS-STN

MICRO-ALU profile and PL-PDM mounting bracket
profil MICRO-ALU z mocownikiem PL-PDM

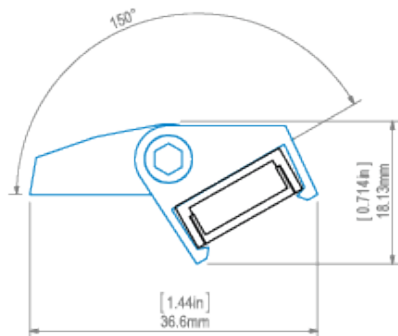

MICRO-ALU profile and REG-PD-UV mounting bracket
profil MICRO-ALU z mocownikiem REG-PD-UV

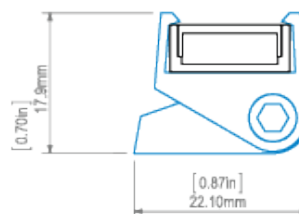

MICRO-ALU profile and REG-PD-UV mounting bracket
profil MICRO-ALU z mocownikiem REG-PD-UV

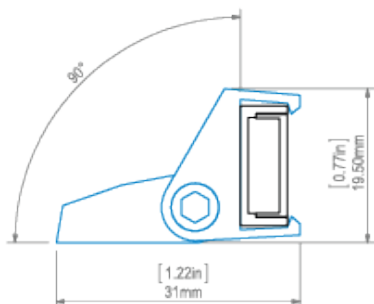

MICRO-ALU profile and REG-PD-UV mounting bracket
profil MICRO-ALU z mocownikiem REG-PD-UV

RELATED PRODUCTS

COVERS

BLACK COVERS

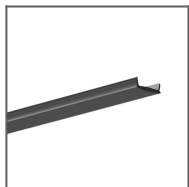

LIGER black Cover

Ref: 17040

90°



CLEAR COVERS

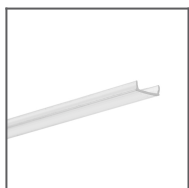

KA clear Cover

Ref: 17036

110°

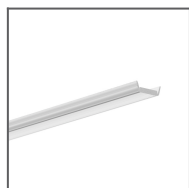

HS clear Cover

Ref: 1370

110°

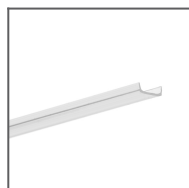

KA-COM clear Cover

Ref: 17122

100°

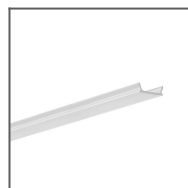

KA-PRO clear Cover

Ref: 17065

100°



FROSTED COVERS



KA frosted Cover

Ref: 17035

110°



M-K frosted Cover

Ref: 17038

160°

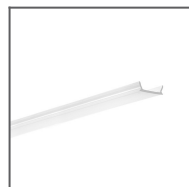
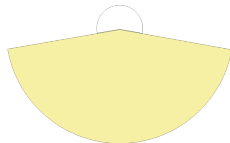

KA-PRO frosted Cover

Ref: 17064

100°

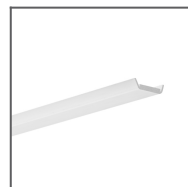

HS frosted Cover

Ref: 1369

110°



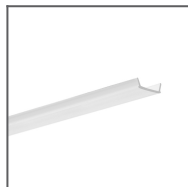

KA-COM frosted Cover
Ref: 17121

110°

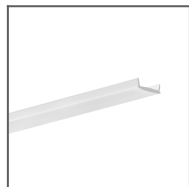

LIGER frosted Cover
Ref: 17037

120°



END CAPS

REGULAR END CAPS

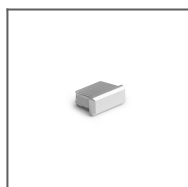

MICRO-ALU metalized End cap
Ref: 24062

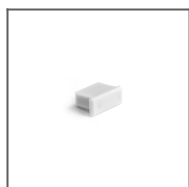

MICRO-ALU grey End cap
Ref: 1058



M-K grey End cap
Ref: 24216

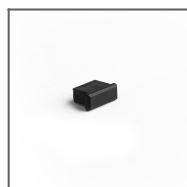

MICRO-ALU black End cap
Ref: 24068

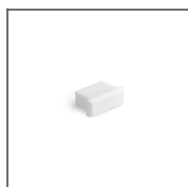

MICRO-ALU white End cap
Ref: 20001

REGULAR END CAPS WITH HOLE



MICRO-ALU-OTW grey End cap
Ref: 1060

MICRO SWITCH WITH HOLE



MICRO-ALU-OTW-MW
grey End cap
Ref: 00024

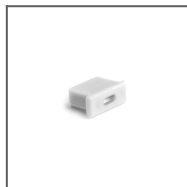

MICRO-ALU-OTW-MW
white End cap
Ref: 23001

ELECTRICITY CONDUCTIVE END CAPS



Electricity
conductive MICRO
End cap
Ref: 1443



MICRO-M3 grey
electricity
conductive End
cap
Ref: 42601

ACCESSORIES

FASTENERS & MOUNTING ACCESSORIES



PIONISA Mounting
bracket
Ref: 24122

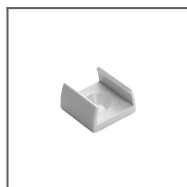

PL-PDM Mounting
bracket
Ref: 24041

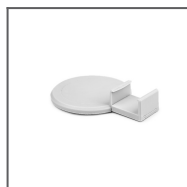

PLANISA
Mounting bracket
Ref: 24121



PDS Mounting
bracket
Ref: 24189

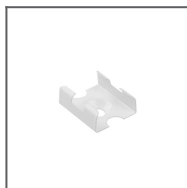

PDS Mounting
bracket
Ref: 24223



REG-PD-UV
Mounting bracket
Ref: 24270



PDS-STN
Mounting bracket
Ref: 24190

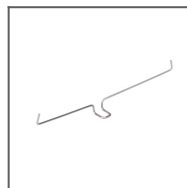

PDS Spring
Ref: 00800



ZZ Head
Ref: 42218



ZO Head
Ref: 42217



BZP-ZO Head
Ref: 42214



BZP-ZZ Head
Ref: 42215



ST Head
Ref: 42216



BZP Head
Ref: 42213



PUSZ-LIN-MR
Fastener silver
Ref: 42278



PUSZ-PRET-MR
Fastener
Ref: 42252



PUSZ-LIN-MR
Fastener
Ref: 42258



PUSZ-LIN-MR
Fastener black
Ref: 42278L9005



PUSZ-PRET-MR
Fastener silver
Ref: 42281



PUSZ-PRET-MR
Fastener black
Ref: 42281L9005



FI-8-LIN-MR
Fastener silver
Ref: 42287



FI-8-LIN-MR
Fastener black
Ref: 42287L9005



DP-ZZ Fastener
Ref: 00651



DP-MOC-ZO
Fastener
Ref: 00646



DP-ZO Fastener
Ref: 00649

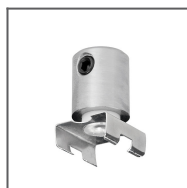

DP-MOC Fastener
Ref: 00645

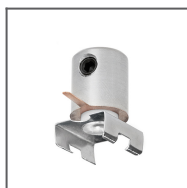

DP-MOC-ZZ
Fastener
Ref: 00647



DP Fastener
Ref: 00644

COMPONENTS FOR CONNECTING PROFILES

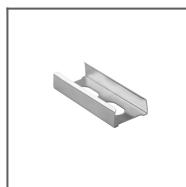

PD-MICRO
Connector
Ref: 42150

MOUNTING SETS



W1 Fastener set
Ref: 42602



W2 Fastener set
Ref: 42603



M3 Fastener set
Ref: 42303



M4 Fastener set
Ref: 42301



M5 Fastener set
Ref: 42302



W6 Fastener set
Ref: 42604



W7 Fastener set
Ref: 42605



W9 Fastener set
Ref: 42607



W10 Fastener set
Ref: 42608



M11 Fastener set
Ref: 42609



M12 Fastener set
Ref: 42610

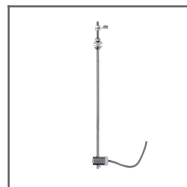

M13 Fastener set
Ref: 42611

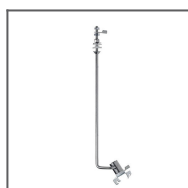

M14 Fastener set
Ref: 42612



RG-1 Fastener set
black
Ref: 42647L9005



RG-1 Fastener set
silver
Ref: 42647NI



RG-1 Fastener set
silver satin
Ref: 42647GSS

SEALING COMPONENTS



6x1,2 Gland
Ref: 00802

LED TAPES

WHITE

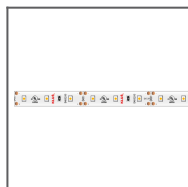

LED strip K-1210-12V
Ref: K-1210-12V

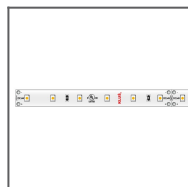

LED strip
K-1210-24V
Ref: K-1210-24V

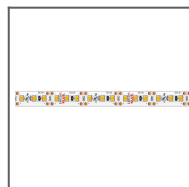

LED strip
K-1220-12V
Ref: K-1220-12V

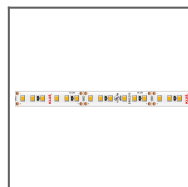

LED strip K-1220-24V
Ref: K-1220-24V

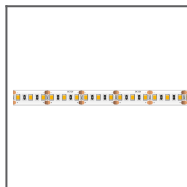

LED strip K-1275-12V
Ref: K-1275-12V

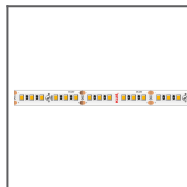

LED strip K-1275-24V
Ref: K-1275-24V

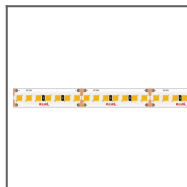

LED strip K-1820-HD-24V
Ref: K-1820-HD-24V



LED strip K-1910-HD-24V
Ref: K-1910-HD-24V

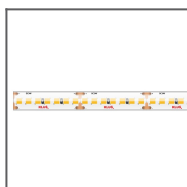

LED strip WP-K-1640-HD-IP65-24V
Ref: WP-K-1640-HD-IP65-24V

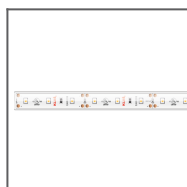

LED strip WP-K-1210-12V
Ref: WP-K-1210-12V



LED strip WP-K-1210-24V
Ref: WP-K-1210-24V



Taśma LED WP-K-1220-12V
Ref: WP-K-1220-12V

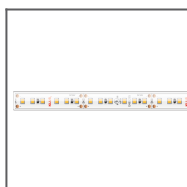

LED strip LED WP-K-1220-24V
Ref: WP-K-1220-24V

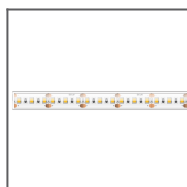

LED strip WP-K-1275-12V
Ref: WP-K-1275-12V



LED strip WP-K-1275-24V
Ref: WP-K-1275-24V

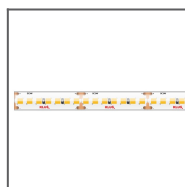

Taśma LED WP-K-1910-HD-IP65-24V
Ref: WP-K-1910-HD-IP65-24V



LED strip WP-K-1220-IP65-12V
Ref: WP-K-1220-IP65-12V

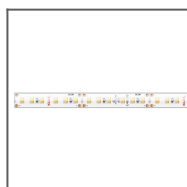

LED strip WP-K-1220-IP65-24V
Ref: WP-K-1220-IP65-24V

HIGH EFFICACY

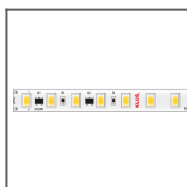

LED strip K-HE-0480-HD-24V
Ref: K-HE-0480-HD-24V

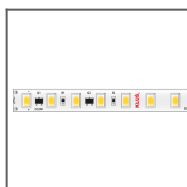

LED strip K-HE-0960-HD-24V
Ref: K-HE-0960-HD-24V

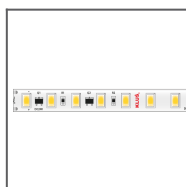

LED strip K-HE-1440-HD-24V
Ref: K-HE-1440-HD-24V

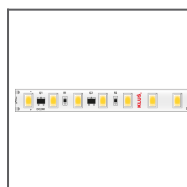

LED strip K-HE-1920-HD-24V
Ref: K-HE-1920-HD-24V

LONG RUN

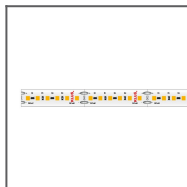

LED strip K-
LR-1000-24V
Ref: K-
LR-1000-24V

CRI 95+



LED strip WP-K-
CR-1210-24V
Ref: WP-K-
CR-1210-24V

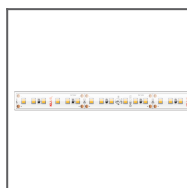

LED strip WP-K-
CR-1220-24V
Ref: WP-K-
CR-1220-24V

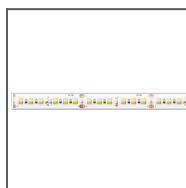

LED strip WP-K-
CR-1275-24V
Ref: WP-K-
CR-1275-24V

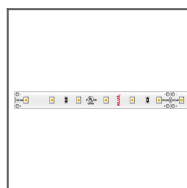

LED strip K-
CR-1210-24V
Ref: K-
CR-1210-24V



LED strip K-
CR-1220-24V
Ref: K-
CR-1220-24V



LED strip K-
CR-1275-24V
Ref: K-
CR-1275-24V

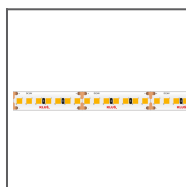

LED strip K-
CR-1820-HD-24V
Ref: K-CR-1820-
HD-24V

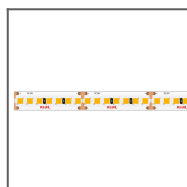

LED strip K-
CR-1910-HD-24V
Ref: K-CR-1910-
HD-24V

RGB / RGB-W

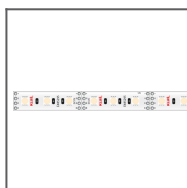

LED strip K-1275-
RGB-12V
Ref: K-1275-RGB-12V

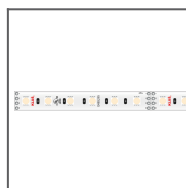

LED strip K-1275-
RGB-24V
Ref: K-1275-
RGB-24V

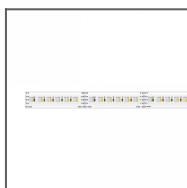

LED strip K-1530-
RGB+W-24V
Ref: K-1530-
RGB+W-24V

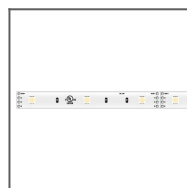

LED strip K-1215-
RGB-12V
Ref: K-1215-
RGB-12V

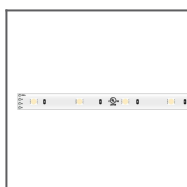

LED strip K-1215-
RGB-24V
Ref: K-1215-RGB-24V

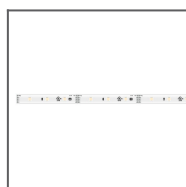

LED strip K-1225-
RGB-12V
Ref: K-1225-
RGB-12V

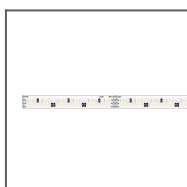

LED strip K-1225-
RGB-24V
Ref: K-1225-
RGB-24V

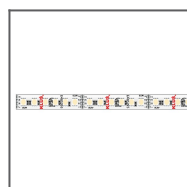

LED strip
K-1920-120-RGB-24V
19.2W/m
Ref: K-1920-120-
RGB-24V

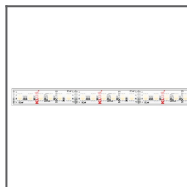

LED strip WP-
K-1920-120-RGB-24V
Ref: WP-K-1920-120-
RGB-24V

TUNABLE WHITE / DIM TO WARM

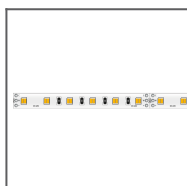

LED strip
K-27/65-1920-24V
Ref:
K-27/65-1920-24V



LED strip WP-
K-27/65-1920-24V
Ref: WP-
K-27/65-1920-24V

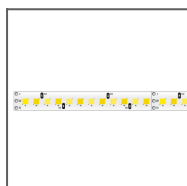

LED strip
K-22/50-1728-24V
Ref:
K-22/50-1728-24V

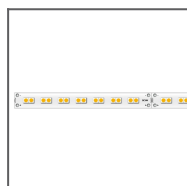

LED strip
K-30/18-1770-24V
Ref:
K-30/18-1770-24V

MARKETING MATERIALS



Display
P230-90120M
Ref: 90120M



Display
P230-90083M
Ref: 90083M



Presentation set 1
Ref: 90051