

# Profile DIPOKET

Ref. H1177

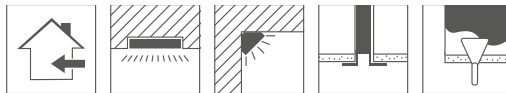
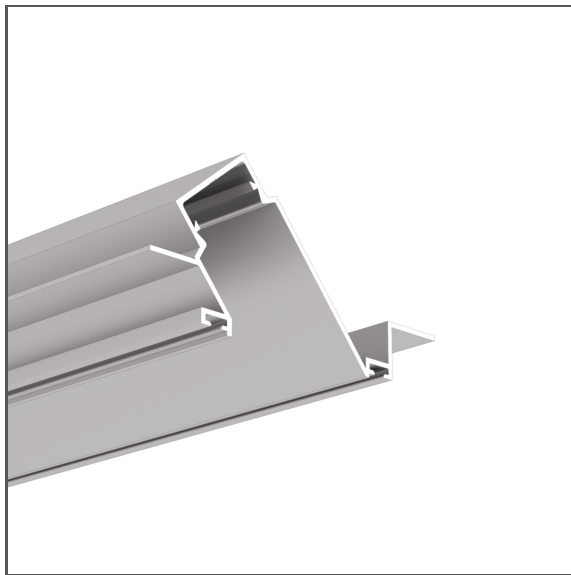

- Linear gallery, stage or exhibition lighting
- The lighting fixture integrates with the mounting surface
- Hidden light source
- Lighting angle: 50 Degrees
- Mounting to 12 mm | 0.47" drywall
- Stable mounting to a suspended ceiling

## APPLICATION

- decorative lighting and functional

## MOUNTING

- in drywall, with screws
- can be easily connected into runs

## ADDITIONAL INFORMATION

- in order to protect the lighting fixture during installation, a TECH-22 protective insert should be used

## TECHNICAL DRAWING

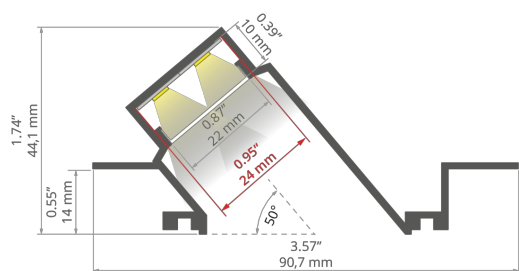

## TECHNICAL SPECIFICATIONS

Material	aluminum	Color	Length	Ref
Possible shapes of the luminaire	flat (embedded in the surface)		1000 mm	H1177L9010OD_1
LED gluing width A	22 mm	<input type="checkbox"/> white lacquered	2005 mm	H1177L9010OD_2
The cover is cut to the length of the profile	yes		3010 mm	H1177L9010OD_3
Can be easily connected into runs	yes		1000 mm	H1177NA_1
Decorative lighting	yes	non anodized	2005 mm	H1177NA_2
Functional lighting	yes		3010 mm	H1177NA_3
Mounting to drywall	yes			
Possibility of obtaining a line of light	yes			
To cover with plaster	yes			
Wire out back of extrusion	yes			





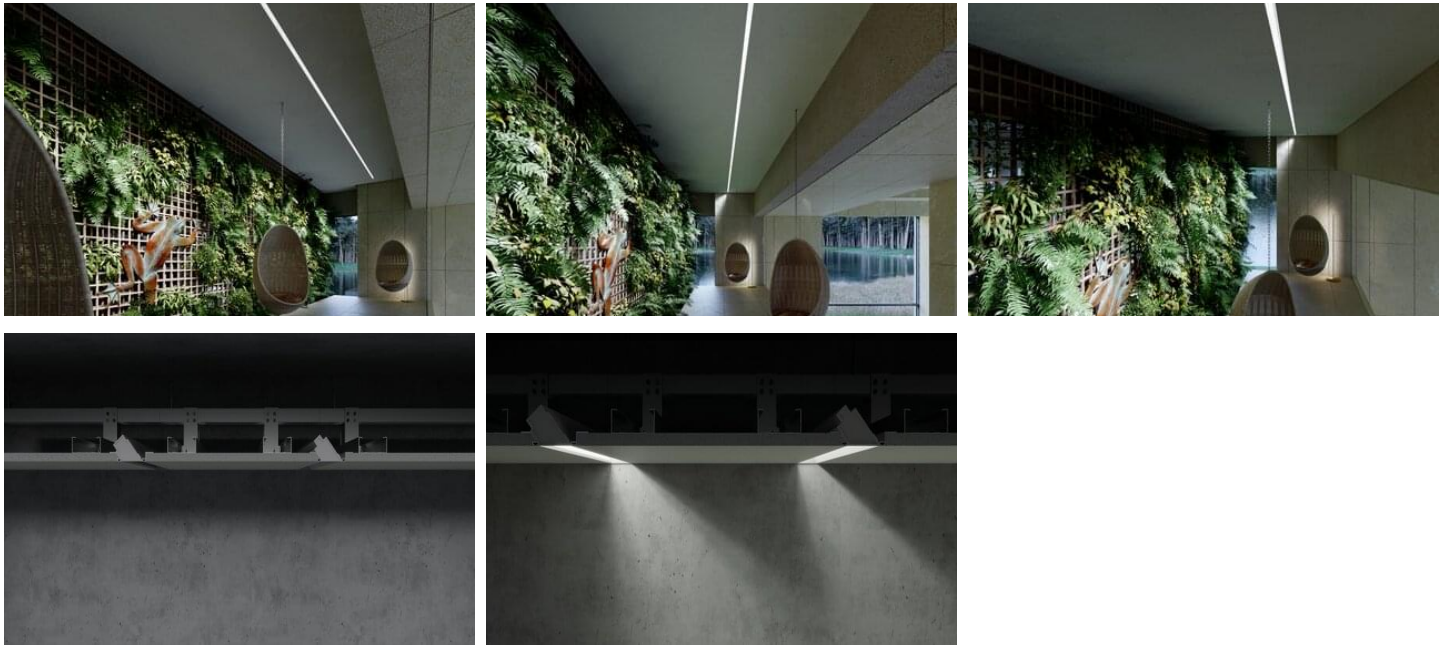

# Profile DIPOKET

Ref. H1177



## SAMPLE PROJECTS



## COVERS

NAME	MATERIAL	MATERIAL TRANSMITTANCE	COLOR	REF.
DILENSO	PC		 clear	17173
MUN-22	PC	86 %	 semi-transparent	17042
HS-22	PC	73 %	 frosted	17011
		94 %	 clear	17022
LIGER-22	PC	62 %	 frosted	17032V1
		39 %	 black	17087

## END CAPS

NAME	MATERIAL	COLOR	REF.
DIPOKET	PP	 gray	24461
		 white	24462

## OTHER ACCESSORIES



CONNECTOR  
**ZM-NA-60**  
42305



CONNECTOR  
**ZM-NA-PION-45**  
42315

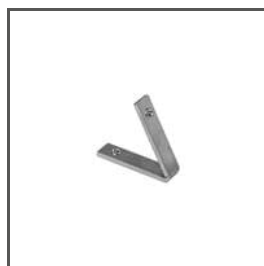

CONNECTOR  
**ZM-NA-PION-60**  
42317



CONNECTOR  
**ZM-NA-PION-120**  
42321

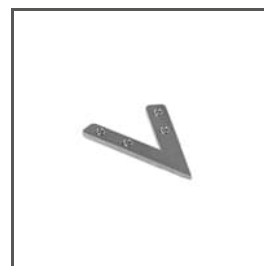

CONNECTOR  
**ZM-NA-45**  
42339



CONNECTOR  
**ZM-NA-90**  
42723



CONNECTOR  
**ZM-NA-180**  
42724



CONNECTOR  
**ZM-NA-135**  
42725



CONNECTOR  
**ZM-NA-PION-90**  
42726



CONNECTOR  
**ZM-NA-PION-135**  
42727



CONNECTOR  
**ZM-NA-120**  
42729