

# Profile REGULOR

Ref. A18068

Ref. arch B468+43

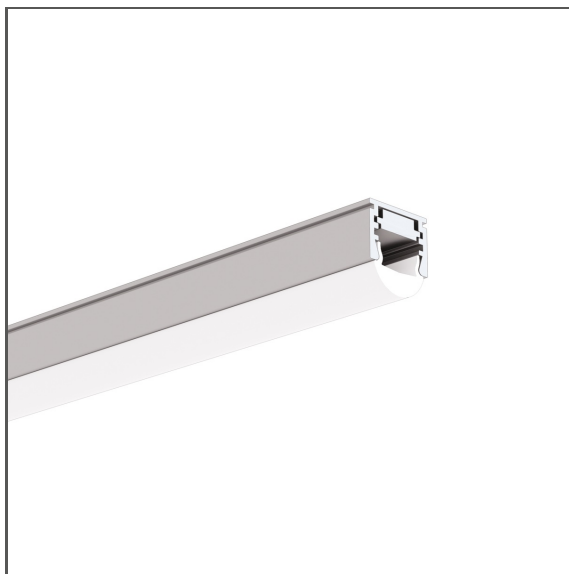

- Adjustable lighting angle
- Wide range of accessories

## APPLICATION

- main and decorative lighting

## MOUNTING

- to the surface, suspended or recessed, using dedicated accessories, properly selected screws, with double-sided adhesive tape or mounting adhesive
- easy assembly and disassembly by snapping in and out

## ADDITIONAL INFORMATION

- thanks to the adjustable LED insert, the profile can be configured to obtain lighting angles of: 10, 30, 45, 60 or 90 degrees
- standard lengths of KLUŚ profiles and covers: 1000 mm (tolerance  $\pm 1.5$  mm) and 2005 mm / 3010 mm (tolerance + 5 mm); for selected covers: 6050 mm, 10050 mm (tolerance + 5 mm)
- when choosing a different length of profiles / covers than available in the standard, you should additionally choose the cutting service at KLUŚ

## TECHNICAL DRAWING

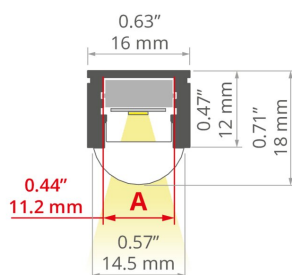

## TECHNICAL SPECIFICATIONS

Material	aluminum
Color	silver anodized
Possible fixture IP	20, 67
Width	16 mm
Height	12 mm
LED gluing width A	11.2 mm
Number of LED strips A (8 mm wide)	1
Beam angle adjustment from	10
Beam angle adjustment up to	90
Building type	Outdoor
Facility zone	urban architecture, green architecture, facade lighting, stairs and handrails, wejścia i bramy
Easy assembly and disassembly by snapping in and out	yes
The cover is cut to the length of the profile	yes
Wire out end cap	yes
Wire out back of extrusion	yes

Length	Ref
1000 mm	A18068A_1 B468+43ANODA_1
2005 mm	A18068A_2 B468+43ANODA_2
3010 mm	A18068A_3 B468+43ANODA_3

# Profile REGULOR



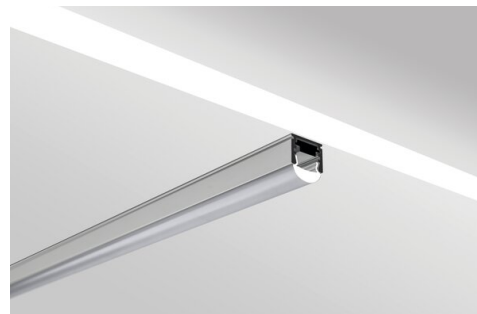

Ref. A18068

Ref. arch B468+43





## SAMPLE PROJECTS



## RELATED ACCESSORIES > RELATED COVERS

NAME	MATERIAL	MATERIAL TRANSMITTANCE	COLOR	REF.
S	 PC	73 %	 clear	B17202T 00220
S-SATYNA	 PC	67 %	 clear	B17202S 17111

## RELATED ACCESSORIES > RELATED END CAPS

NAME	MATERIAL	COLOR	REF.
REGULOR	 PP	 gray	C20116C02 00310
REGULOR-OTW	 PP	 gray	C20116C02TW 00313

## RELATED ACCESSORIES > RELATED LED



**8K-WP-K-1275-12V**

\_biąd

Ref. arch 8K-WP-K-1275-12V

## RELATED ACCESSORIES > RELATED LED > HIGH EFFICACY

# Profile REGULOR

Ref. A18068

Ref. arch B468+43

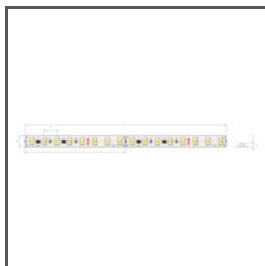

**K-HE-0480-HD-24V**

K-HEHD-0480-24

Ref. arch K-HE-0480-HD-24V

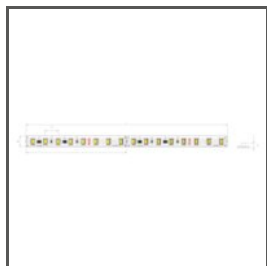

**K-HE-0960-HD-24V**

K-HEHD-0960-24

Ref. arch K-HE-0960-HD-24V

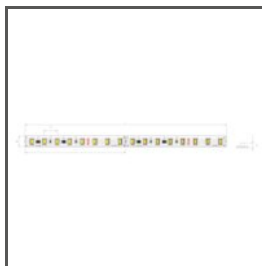

**K-HE-1440-HD-24V**

K-HEHD-1440-24

Ref. arch K-HE-1440-HD-24V

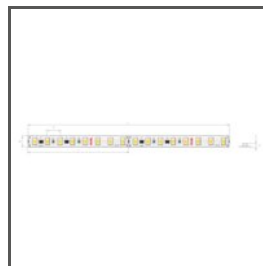

**K-HE-1920-HD-24V**

K-HEHD-1920-24

Ref. arch K-HE-1920-HD-24V

## RELATED ACCESSORIES > OTHER RELATED ACCESSORIES > CONDUCTIVE FASTENERS AND HEADS FOR PROFILES



HEAD

**ZO**

C28115N00

Ref. arch 42217



FASTENER

**PUSZ-PRET-MR**

C28166N00, C28166L10,  
C28166L07

Ref. arch 42281, 42281L9010,  
42281L9005



FASTENER

**PUSZ-LIN-MR**

C28163N00, C28163L10,  
C28163L07

Ref. arch 42278, 42278L9010,  
42278L9005



FASTENER

**FI-8-LIN-MR**

C28172N00, C28172L10,  
C28172L07

Ref. arch 42287, 42287L9010,  
42287L9005

## RELATED ACCESSORIES > OTHER RELATED ACCESSORIES > FASTENERS AND HEADS FOR PROFILES



HEAD

**ST**

C28114N00

Ref. arch 42216



HEAD

**BZP**

C28113N00

Ref. arch 42213

## RELATED ACCESSORIES > OTHER RELATED ACCESSORIES > MOUNTING BRACKETS

# Profile REGULOR

Ref. A18068

Ref. arch B468+43



MOUNTING BRACKET

**PDS-STN**

C24190N00

Ref. arch 24190



MOUNTING BRACKET

**REG-PD-UV**

C28055C02

Ref. arch 24270



MOUNTING BRACKET

**PL-PDM**

C24041C02

Ref. arch 24041



MOUNTING BRACKET

**PDS**

C24189C02, C24223C10

Ref. arch 24189, 24223



MOUNTING BRACKET

**PDS-STN-90G**

C24370N00, C24370L07, C24370L10

Ref. arch 24370, 24370RAL9005, 24370RAL9010



MOUNTING BRACKET

**PDS-STN-90D**

C24367N00, C24367L07, C24367L10

Ref. arch 24367, 24367RAL9005, 24367RAL9010



MOUNTING BRACKET

**PDS-STN-ALFA**

C28060N00

Ref. arch 24426



NEW

MOUNTING BRACKET

**PDS-STN-45D**

C24456N00

Ref. arch 24456



NEW

MOUNTING BRACKET

**PDS-STN-60D**

C24457N00

Ref. arch 24457

## RELATED ACCESSORIES > OTHER RELATED ACCESSORIES > OTHER



GLAND

**6x1,2**

C24517C07

Ref. arch 00802

## RELATED ACCESSORIES > OTHER RELATED ACCESSORIES > SUSPENSION AND MOUNTING SETS



ARM

**K5G-AB**

C28270N00

Ref. arch 42051



FASTENER SET

**W1**

C28203N00

Ref. arch 42602



FASTENER SET

**W2**

C28204N00

Ref. arch 42603



FASTENER SET

**M3**

C28182N00

Ref. arch 42303



FASTENER SET

**M4**

C28180N00

Ref. arch 42301

# Profile REGULOR

Ref. A18068

Ref. arch B468+43



FASTENER SET

**M5**

C28181N00

Ref. arch 42302



FASTENER SET

**W6**

C28205N00

Ref. arch 42604

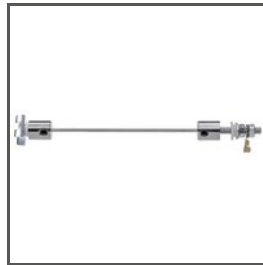

FASTENER SET

**W9**

C28207N00

Ref. arch 42607

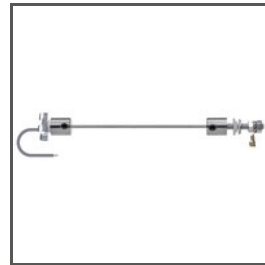

FASTENER SET

**W10**

C28208N00

Ref. arch 42608



FASTENER SET

**RG-1**

C28230P00, C28230P01,

C28230L10, C28230L07

Ref. arch 42647NI, 42647GSS,  
42647L9010, 42647L9005