

# Profile STEPUS

Ref. A18038

Ref. arch 18038

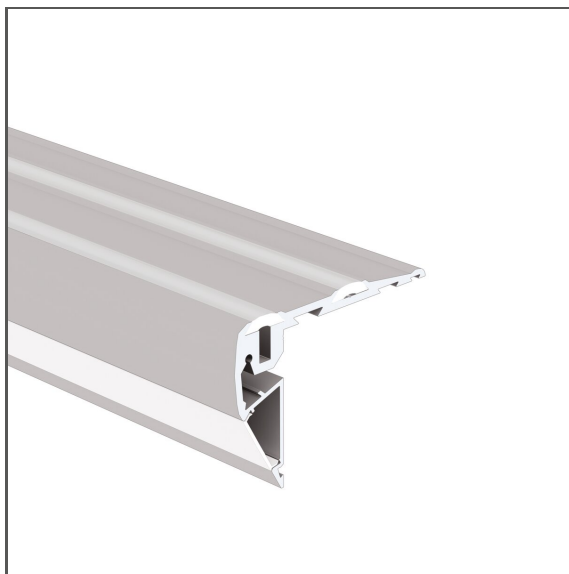

- For installation on the steps
- Conforms to the American ADA norms
- Non-slip elements
- Two lighting options
- High mechanical resistance

## APPLICATION

- warning lighting and anti-slip protection on the steps

## MOUNTING

- to a step, using properly selected screws

## ADDITIONAL INFORMATION

- standard lengths of KLUŚ profiles and covers: 1000 mm (tolerance  $\pm 1.5$  mm) and 2005 mm / 3010 mm (tolerance + 5 mm); for selected covers: 6050 mm, 10050 mm (tolerance + 5 mm)
- when choosing a different length of profiles / covers than available in the standard, you should additionally choose the cutting service at KLUŚ

## TECHNICAL DRAWING

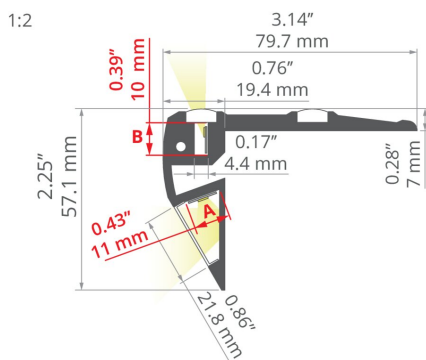

## TECHNICAL SPECIFICATIONS

Material	aluminum
Possible fixture IP	20, 67
Width	79.7 mm
Height	56.1 mm
LED gluing width A	11 mm
LED gluing width B	10 mm
Number of LED strips A (8 mm wide)	1
Possibility of obtaining a line of light	yes
Building type	Commercial, Retail, Entertainment/ Arts, HoReCa object
Facility zone	stairs and handrails
The cover is cut to the length of the profile	yes
Wire out back of extrusion	yes

Color	Length	Ref
■ silver anodized	1000 mm	A18038A_1 18038ANODA_1
	2005 mm	A18038A_2 18038ANODA_2
	3010 mm	A18038A_3 18038ANODA_3
■ black anodized	1000 mm	A18038A07_1 18038K7_1
	2005 mm	A18038A07_2 18038K7_2
	3010 mm	A18038A07_3 18038K7_3

# Profile STEPUS



Ref. A18038

Ref. arch 18038

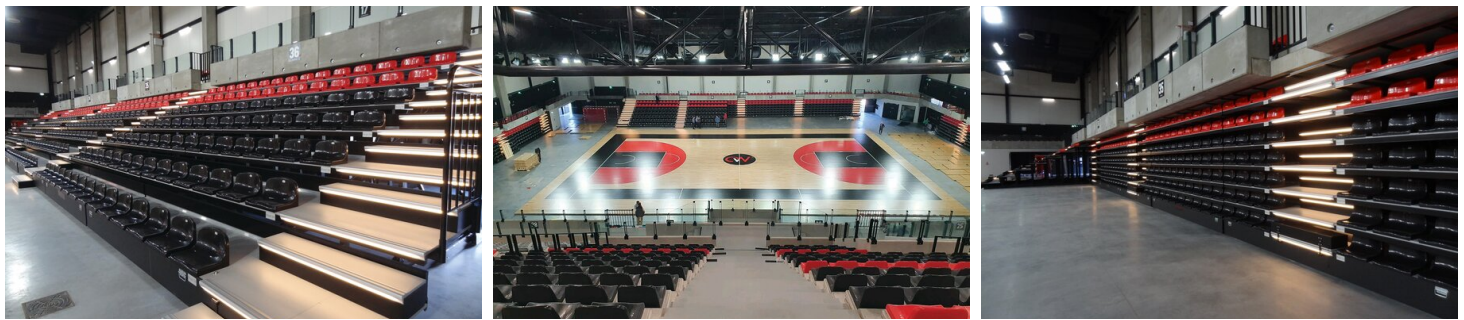

## SAMPLE PROJECTS



## RELATED ACCESSORIES > RELATED COVERS

NAME	MATERIAL	MATERIAL TRANSMITTANCE	COLOR	REF.
HS-22		73 %	<input type="checkbox"/> frosted	B17011M 17011
		94 %	<input checked="" type="checkbox"/> clear	B17011T 17022
LIGER-22		62 %	<input type="checkbox"/> frosted	B17032M 17032V1
		B17032M 17032V1OP		
MUN-22		39 %	<input checked="" type="checkbox"/> black	B17032C 17087
		86 %	<input checked="" type="checkbox"/> semi-transparent	B17042F 17042

## RELATED ACCESSORIES > RELATED END CAPS

NAME	MATERIAL	COLOR	REF.
STEPUS-L		<input checked="" type="checkbox"/> gray	C28011C02 24229
		<input checked="" type="checkbox"/> black	C28011C07 24317
STEPUS-P		<input checked="" type="checkbox"/> gray	C28012C02 24230
		<input checked="" type="checkbox"/> black	C28012C07 24318

## RELATED ACCESSORIES > RELATED LED > HIGH EFFICACY

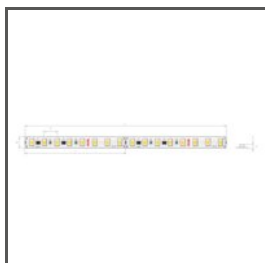

**K-HE-0480-HD-24V**

K-HEHD-0480-24

Ref. arch K-HE-0480-HD-24V

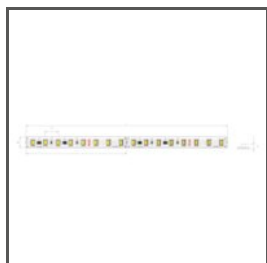

**K-HE-0960-HD-24V**

K-HEHD-0960-24

Ref. arch K-HE-0960-HD-24V

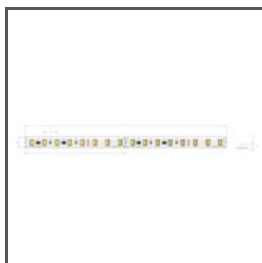

**K-HE-1440-HD-24V**

K-HEHD-1440-24

Ref. arch K-HE-1440-HD-24V

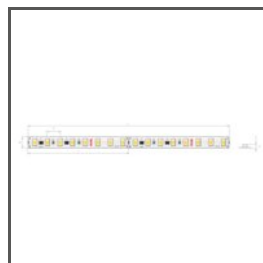

**K-HE-1920-HD-24V**

K-HEHD-1920-24

Ref. arch K-HE-1920-HD-24V

### RELATED ACCESSORIES > RELATED LED > SIDE EMITTING



**K-SE-1210-8-24V**

K-SE-1210-24-8

Ref. arch K-SE-1210-8-24V



**WP-K-SE-1210-8-24V**

KWP-SE-1210-24-8

Ref. arch WP-K-SE-1210-8-24V

### RELATED ACCESSORIES > OTHER RELATED ACCESSORIES > ADDITIONAL ITEMS



TOOL

C28063

Ref. arch 00023

### RELATED ACCESSORIES > OTHER RELATED ACCESSORIES > OTHER

# Profile STEPUS

Ref. A18038

Ref. arch 18038



GLAND

**6,4x3**

C42264C07

Ref. arch 42264

---

## RELATED ACCESSORIES > OTHER RELATED ACCESSORIES > PROFILE MASKING COVERS



MASKING COVER

**MP-22**

C28261L01\_0.25,

C28261L10\_0.25,

C28261L07\_0.25

Ref. arch 17167, 17167L9010,  
17167L9005

---

## RELATED ACCESSORIES > OTHER RELATED ACCESSORIES > SILICONE CORDS



ANTI-SLIP RUBBER STRIP

**14**

C24537C00

Ref. arch 17001