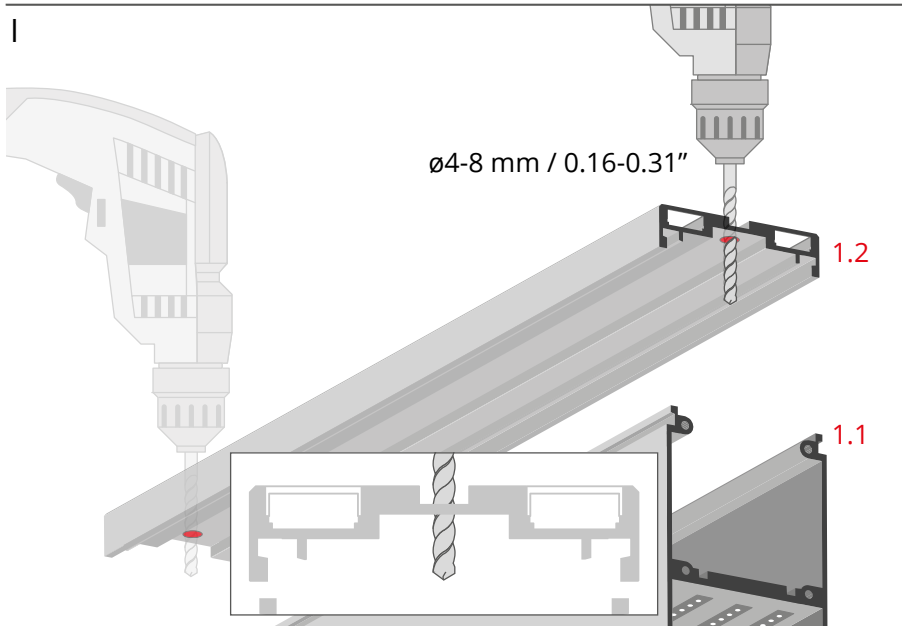
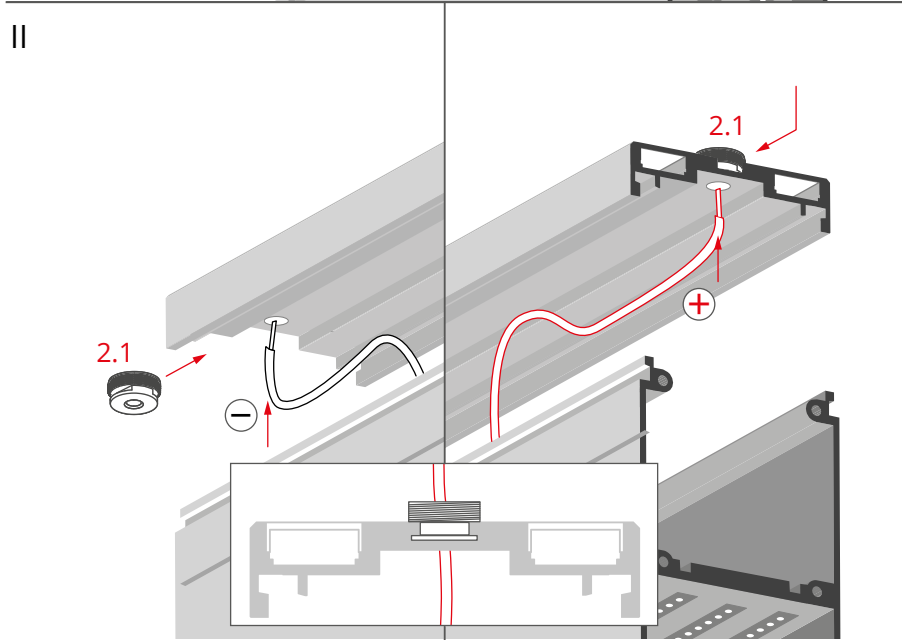
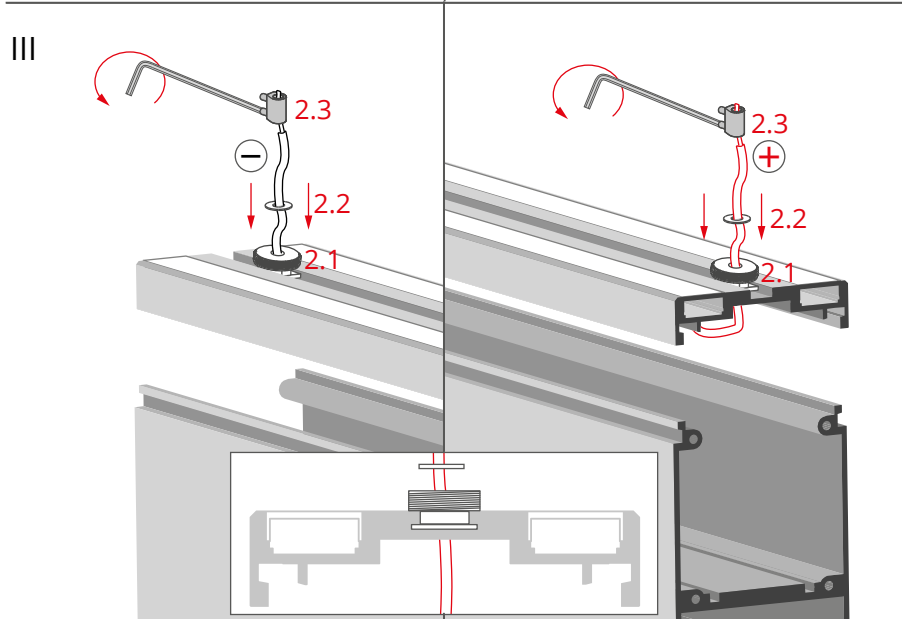

- | | |
|--------------------------------|---|
| 1.1 Profile with LED strip | } Lighting fixture |
| 1.2 Mounting track | |
| 2.1 Threaded plug | } PUSZ-LIN-ZD silver (ref. 42279), black (ref. 42279L9005), white (ref. 42279L9010) |
| 2.2 Washer | |
| 2.3 Power connector | |
| 2.4 Wire crimp | |
| 2.5 Sleeve | |
| 2.6 Head | |
| 2.7 Fastener body | |
| 3. Steel cable* | |
| 4. Ceiling fastener* | |
| 5. Power supply (12 V / 24 V)* | |

*The full range of accessories and electronics is available at www.KlusDesign.eu

NOTE! All LED tapes must be connected to a 12 V or 24 V power supply.

IMPORTANT: Not all possible mounting procedures are presented here. More mounting procedures and related accessories can be found at www.KlusDesign.eu. Drawings of extrusions and accessories in these instructions are simplified and only approximate the actual shapes.

<p>I</p>  <p>ø4-8 mm / 0.16-0.31"</p> <p>1.2</p> <p>1.1</p>	<p>Drill holes with a diameter of 4-8 mm / 0.16-0.31" in the back of the mounting track (1.2). One hole per fastener.</p>
<p>II</p>  <p>2.1</p> <p>2.1</p> <p>+</p> <p>-</p>	<p>Set the threaded plug (2.1) in the groove on the top of the fixture and above the pre-drilled hole. Run a cable from one pole of the LED strip through the hole and the plug.</p>
<p>III</p>  <p>2.3</p> <p>2.3</p> <p>2.2</p> <p>2.2</p> <p>2.1</p> <p>2.1</p> <p>-</p> <p>+</p>	<p>Run the cable through the washer (2.2) and into the power connector (2.3). Lock the cable in the power connector with the use of an allen wrench.</p> <p>NOTE: In case of an external power cable, skip the power connector (2.3).</p>

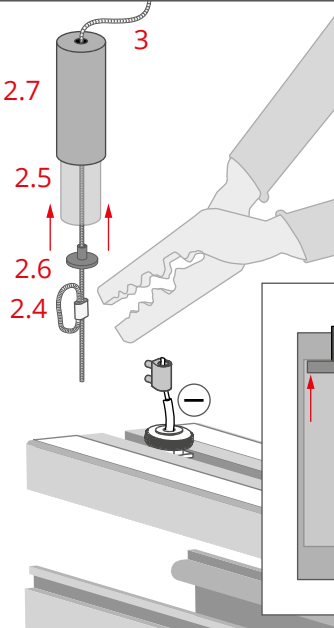
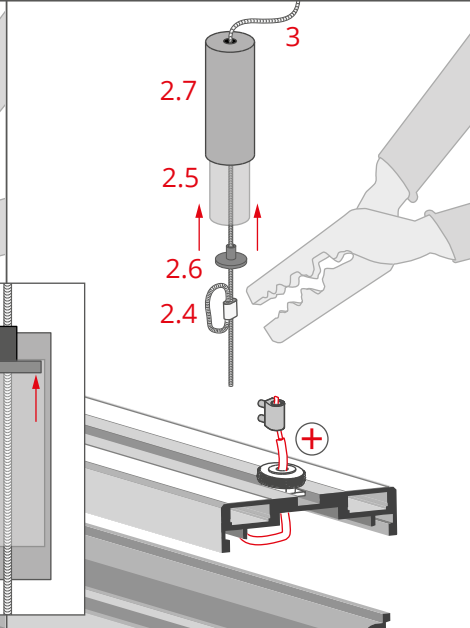
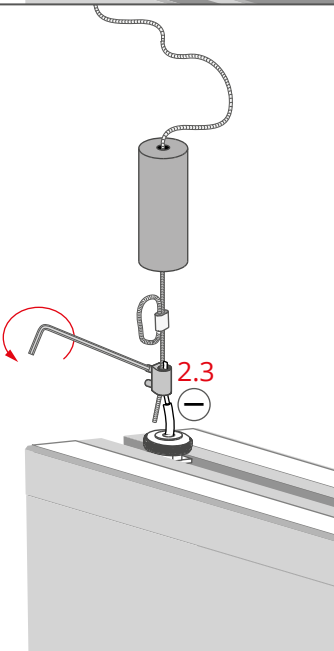
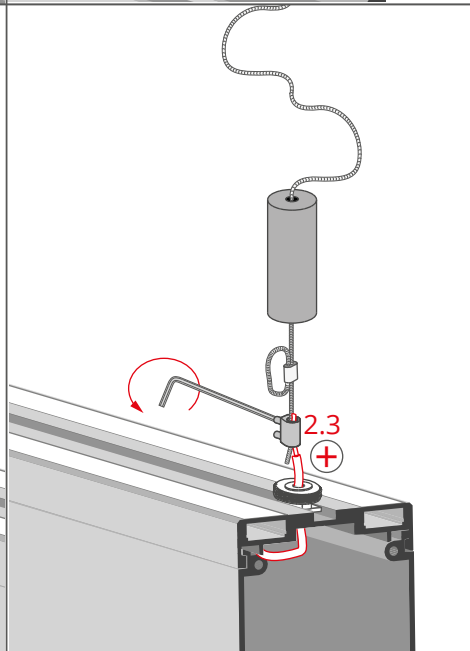
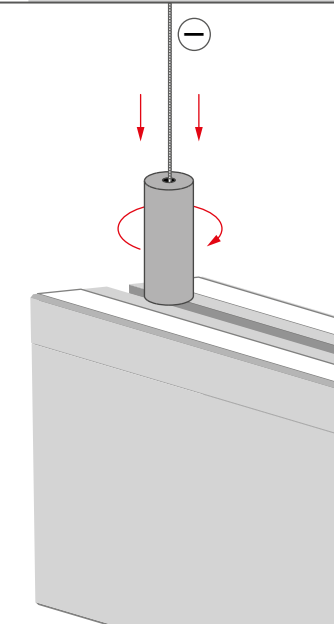
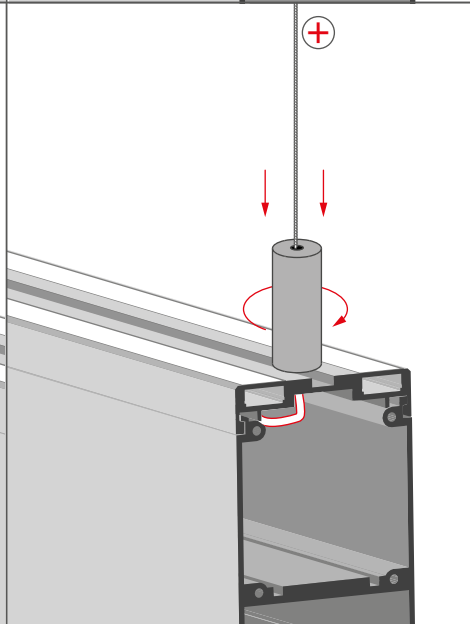
<p>IV</p> 		<p>Insert the sleeve (2.5) and the head (2.6) into the fastener body (2.7) and run the steel cable (3) through it, then run the cable twice through a wire crimp (2.4). Squeeze the wire crimp with e.g. pliers to stop the steel cable from moving.</p> <p>NOTE: In case of an external power cable, skip the sleeve (2.5).</p>
<p>V</p> 		<p>Insert the end of the steel cable into the power connector (2.3) and secure it by tightening the screws of the power connector with the allen wrench.</p> <p>NOTE: In case of an external power cable, skip this stage.</p>
<p>VI</p> 		<p>Insert the entire assembly into the sleeve and tighten the the fastener body.</p>

VII

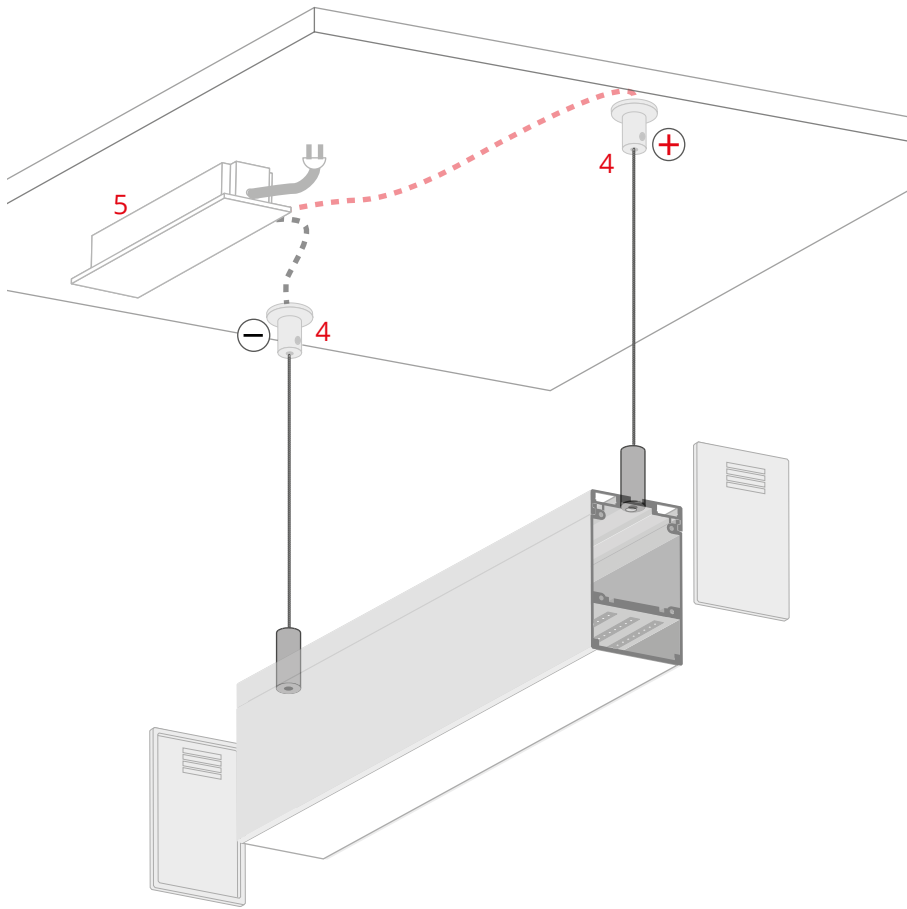

Suspend the lighting fixture from the ceiling fasteners (4) which are connected to the power supply (12 V / 24 V) (5).