

## PRODUCT DESCRIPTION

- Lighting direction of the fixture parallel to the surface
- It can be mounted on the profile before mounting to the surface
- The position can be corrected after screwing
- High mechanical and weather resistance

Fill empty fields

Product nr.

Fixture type

Company

Job name

Date



## TECHNICAL SPECIFICATION

### Application

- for mounting LED lighting fixtures

### Mounting

- to the surface, using properly selected screws
- to the lighting fixture, with hooks
- easy installation and deinstallation of lighting fixtures by snapping in and out

## TECHNICAL DRAWING

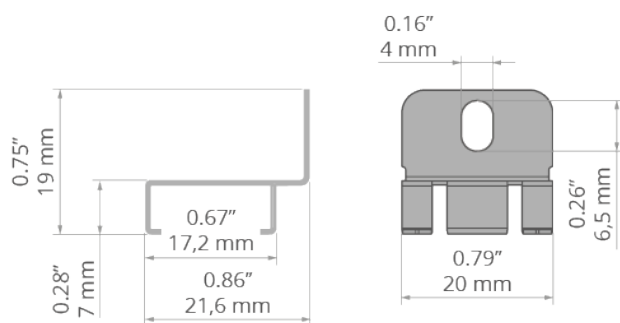

**RELATED PROFILES**



45-16 Profile  
Ref: B8504

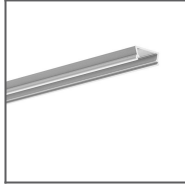

TAMI Profile  
Ref: B5390

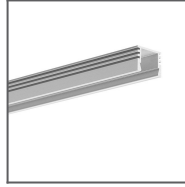

PDS-4-ALU Profile  
Ref: B1718

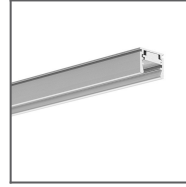

REGULOR Profile  
Ref: B468+43



PDS-O Profile  
Ref: B3777

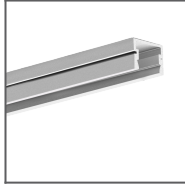

PDS-4-PLUS  
Profile  
Ref: C1263

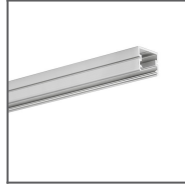

TAPO Profile  
Ref: C1919

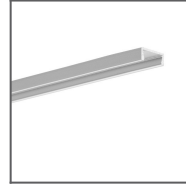

MICRO-PLUS  
Profile  
Ref: C2966

## RELATED PRODUCTS

## MARKETING MATERIALS



Display  
P230-90276M  
Ref: 90276M