











Parts needed to assemble and mount the W10 fastener set

- Top nut (K) 
- Locking washer (J) 
- Power connector (I) 
- Bottom nut (H) 
- Metal washer (G) 
- Top washer (F) 
- Bottom washer (E) 
- Hollow rod (D) 
- Top head (C) 
- Arm (B) 
- Conductive head with mounting bracket 

Tools needed for mounting:

- drill
- pliers
- Allen wrench

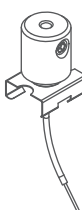
NOTE! A list of products corresponding with the selected accessories is available at www.klusdesign.eu/uk.

1. Drill a hole with a diameter of 10 mm in the mounting surface. The hole must be next to the cable with a single pole. Connect the end of the cable to the power connector (I).

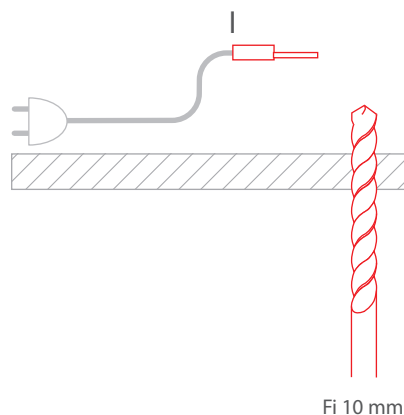

2. Insert the hollow rod (D) into the drilled hole. From the inside, put on in sequence: top washer (F), metal washer (G), bottom nut (H), power connector, locking washer (J), and top nut (K).

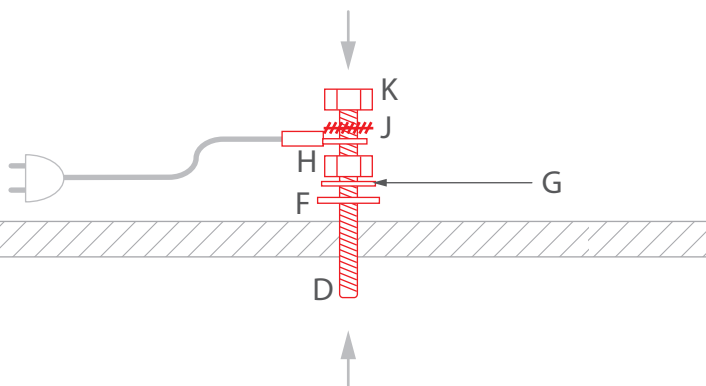

3. Put the bottom washer (E) and the top head (C) on the bottom part of the rod.

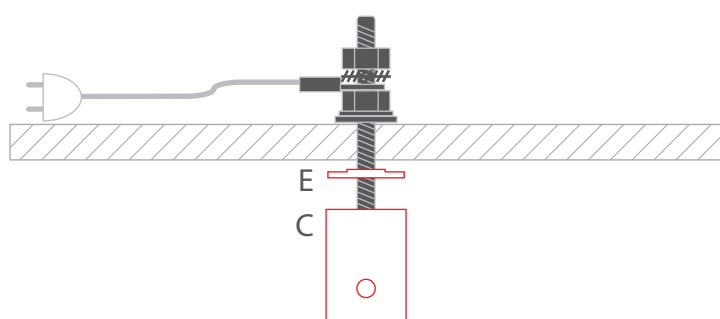

4. Connect the power cable from the head with the mounting bracket (A) to a LED strip in the assembled light fixture.



5. Insert the arm (B) into the mounting bracket of the head. It must press the power cable. Block the arm by tightening the pressure screw in the head with the Allen wrench.

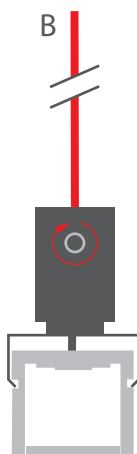

6. Attach the light fixture with the arm (B) to the top head (C). Block the arm by tightening the pressure screw in the top head with the Allen wrench.

